

Article number: 201138640

Description: E+G stainless steel-ball lock pin
GN 113.8-6-40

Measures

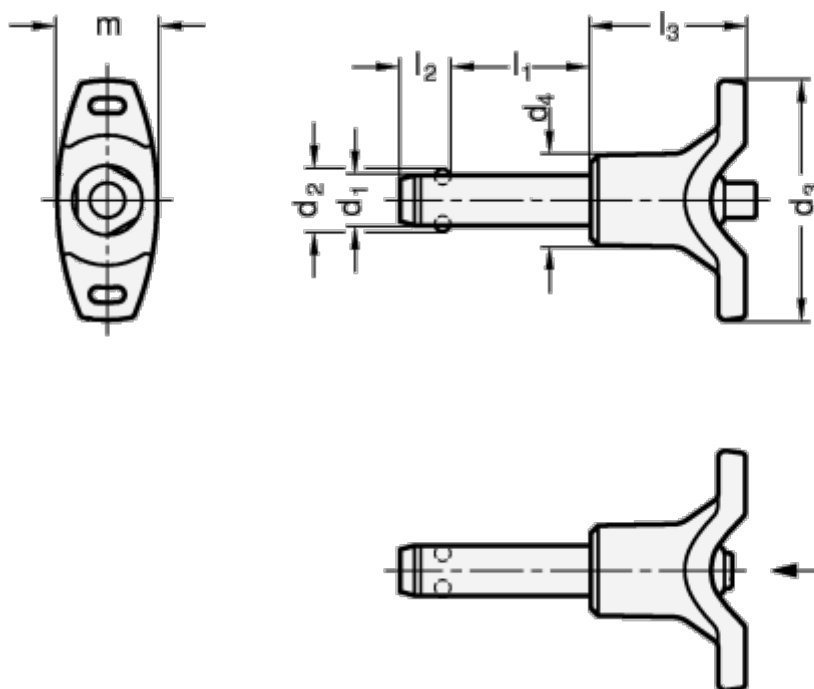

d1 = 6
d2 = 7.0
d3 = 40
d4 = 13.5
l1 = 40
l2 = 7.1
l3 = 25.0
m = 15.5

Resilience (N) = 35